

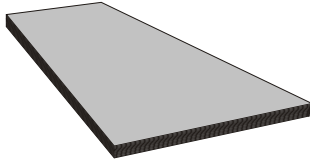

# Slimline® Panel Accessories Guide

## Flat Sheets



- 26 ga. Galvalume, 41-9/16" wide x 120" long  
Color: (to match roof panels)
- 24 ga. Galvalume, 48" wide x 120" long  
Color: (to match roof panels)
- 0.032" Aluminum, 48" wide x 120" long  
Color: (to match roof panels)

### Flat Sheets

In matching gauge and color as roof panels  
Use for fabrication of trims and flashings

## Repel™ Underlayment

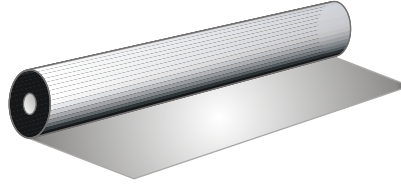

**Repel™ Synthetic Underlayment**  
48" wide x 250' long rolls (10 squares/roll)

## Tube Sealant

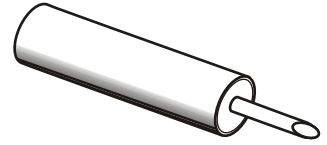

- Ultra 1000 Sealant** (Required for Weather-tight warranty applications)  
Colors: Translucent, Gutter Gray, Dark Bronze, White, Sandstone, Red, Green
- Geocel 2300** Tripolymer  
Color: Clear
- Polyurethane**  
Color: Gray

### Tube Sealant

10 oz. tube (estimate 25 lf/tb at 1/4" bead)

## Tape Sealant

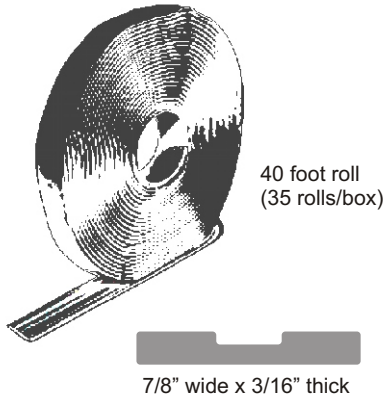

### Double Bead Butyl Tape Sealant

7/8" wide x 3/16" thick x 40 foot roll  
For use under offset cleats and zee closures

## Touch-Up Paint

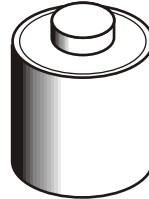

- 2 oz. can for Kynar colors
- 0.6 oz. bottle for SMP colors

### Air Dry Touch-Up Paint

To touch-up small scratches and abrasions  
Note: Color match with roof is not guaranteed

## Pancake Wood Screw

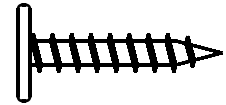

- #10-12 x 1" long
- #10-12 x 1-1/2" long
- #10-12 x 2" long
- #10-12 x 2-1/2" long
- #10-12 x 3" long

### #10-12 Pancake Head Wood Screw

Zinc plated, Quadrex bit  
For attachment of clips and flashings to wood

## Stainless Pancake Screw



Recommended for use  
with aluminum panels

### #10-12" Pancake Head Wood Screw

Stainless Steel, Quadrex Bit  
For attachment of clips and flashings to wood

## Pancake Head Self-Driller

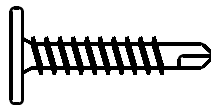

- #10-16 x 1" long
- #12-14 x 1" long

### #10-16 or #12-14 Self-Drilling Screw

Zinc Plated, Quadrex bit  
For attachment of clips and flashings to steel

## Pop Rivet

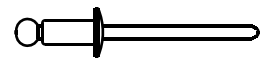

- #1/8 x 3/16" long, Plain or Painted

### Pop Rivet, 1/8" Diameter x 3/16" Grip

Stainless Steel Rivet and Mandrel  
For sheet metal joining. Pre-drill w/ 1/8" hole.

## Lap Tek

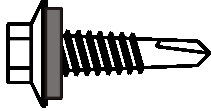

- #1/4-14 x 7/8" long, Plain or Painted

**1/4"-14 x 7/8" SD Lap Tek Screw**  
5/16" HWH w/ washer, Zinc Plated  
For sheet metal joining

## HWH Wood Screw

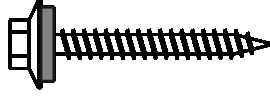

- #10-14 x 1" long, Plain or Painted
- #10-14 x 1-1/2" long, Plain or Painted
- #10-14 x 2" long, Plain or Painted
- #10-14 x 2-1/2" long, Plain or Painted
- #10-14 x 3" long, Plain or Painted

**#10-14 Wood Screw**  
1/4" HWH w/ washer, Zinc Plated  
To attach sheet metal components to wood

## Long-Life LapTek

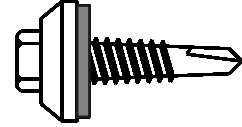

- #1/4-14 x 7/8" long, Plain or Painted

**1/4" x 7/8" SD Ultimate® Lap Tek Screw**  
5/16" HWH Zinc Alloy Head w/ washer  
For sheet metal joining

## Long-Life HWH Wd Screw

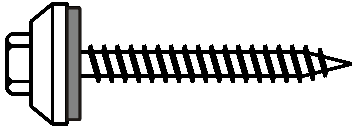

- #10-14 x 1" long, Plain or Painted
- #10-14 x 1-1/2" long, Plain or Painted
- #10-14 x 2" long, Plain or Painted
- #10-14 x 2-1/2" long, Plain or Painted

**#10-14 Ultimate® Wood Screw**  
5/16" HWH Zinc Alloy Head w/ washer  
To attach sheet metal components to wood

## HWH Self-Drilling Screw

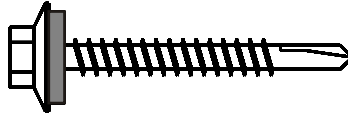

- #12-14 x 1" long, Plain or Painted
- #12-14 x 1-1/4" long, Plain or Painted
- #12-14 x 1-1/2" long, Plain or Painted
- #12-14 x 2-1/2" long, Plain or Painted

**#12-14 Drill Point #2 (DP2)**  
5/16" HWH w/ washer, Zinc Coated  
To attach sheet metal components to steel

## Long-Life HWH SD Screw

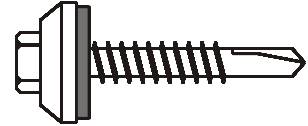

- #12-14 x 1-1/4" long, Plain or Painted

**#12-14 Ultimate® Drill Point #2 (DP2) Screw**  
5/16" HWH Zinc Alloy Head w/ washer  
To attach sheet metal components to steel

## Pipe Boot

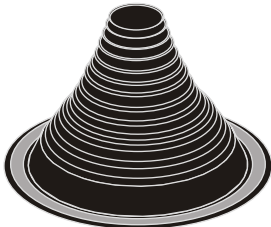

- #3 Boot - Fits 1/4" to 5" diameter (8" base)
- #4 Boot - Fits 3" to 6" diameter (9-1/2" base)
- #5 Boot - Fits 4" to 7" diameter (11" base)
- #6 Boot - Fits 5" to 9" diameter (12-3/4" base)

**Pipe Boot, Black EPDM**  
For use with pipe penetrations

## High Temp. Pipe Boot

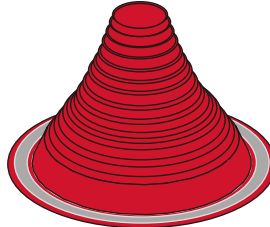

- #3 Boot - Fits 1/4" to 5" diameter (8" base)
- #4 Boot - Fits 3" to 6" diameter (9-1/2" base)
- #5 Boot - Fits 4" to 7" diameter (11" base)
- #6 Boot - Fits 5" to 9" diameter (12-3/4" base)

**High Temp. Pipe Boot, Orange Silicone**  
For high temperature pipe penetrations

## Retrofit Pipe Boot

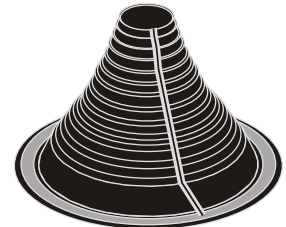

- #1 Boot - Fits 3/4" to 2-3/4" diameter
- #2 Boot - Fits 2" to 7-1/4" diameter
- #3 Boot - Fits 3-1/4" to 10" diameter

**Retrofit Pipe Boot, Black EPDM**  
For use with "wrap-around" applications



# Slimline® Panel Accessories Guide

## Gutter Hanger



- 5" Hidden Gutter Hanger
- 6" Hidden Gutter Hanger
- 7" Hidden Gutter Hanger
- 8" Hidden Gutter Hanger

**Hidden Gutter Hanger, 18 ga. Galvanized**  
For use with GT## gutter profiles

## Gutter End Cap

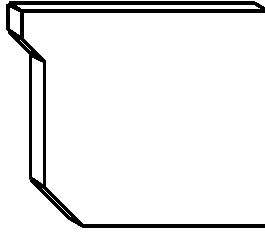

- 5" End Cap, Left and Right
- 6" End Cap, Left and Right
- 7" End Cap, Left and Right
- 8" End Cap, Left and Right

**Gutter End Caps (match gutter material)**  
For use with GT## gutter profiles

## Outlet Tube

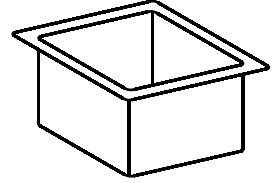

- 3" x 4"
- 4" x 5"
- Custom Size: \_\_\_\_\_

**Downspout Outlet Tube (match gutter matl.)**  
For use with rectangular downspouts

